

## MODELS



Triangle



Square



Rectangle

## POSITIONS

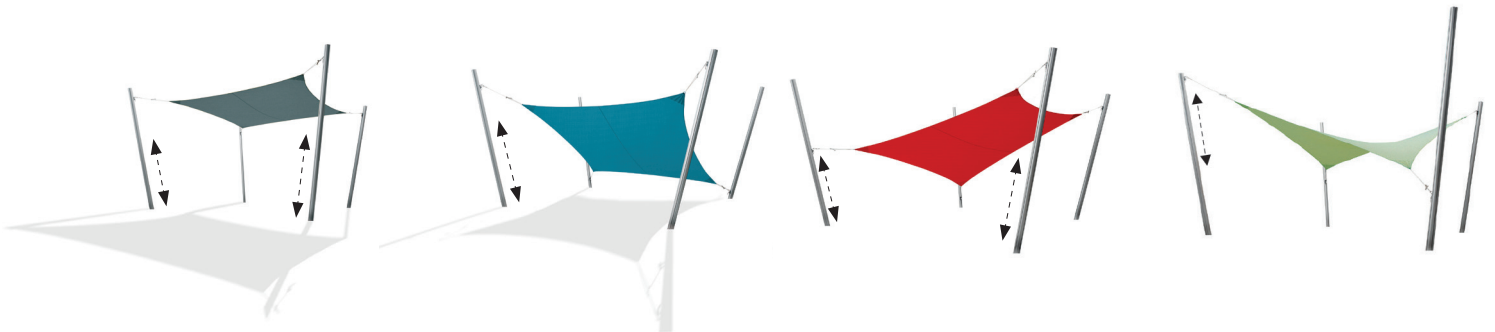

## COLORS

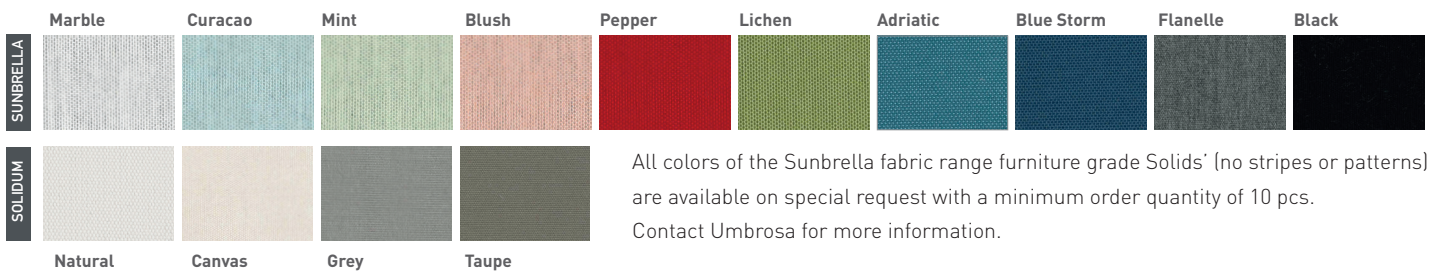

DIMENSIONS

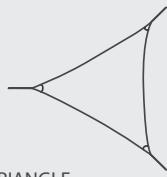

**TRIANGLE**  
 • 4x4x4m/13' 1"x13' 1"x13' 1"  
 • 5x5x5m/16' 5"x16' 5"x16' 5"

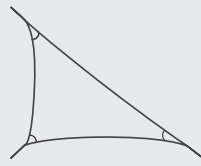

**RIGHT-ANGLED TRIANGLE**  
 • 4x5x6.4m/13' 1"x16' 5"x21'

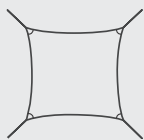
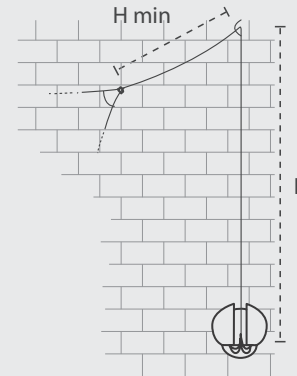
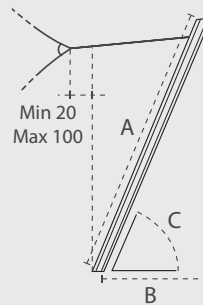

**SQUARE**  
 • 3x3m/9' 10"x9' 10"  
 • 4x4m/13' 1"x13' 1"

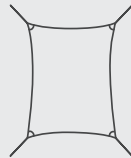

**RECTANGLE**  
 • 3x4m/9' 10"x13' 1"  
 • 3x5m/9' 10"x16' 5"

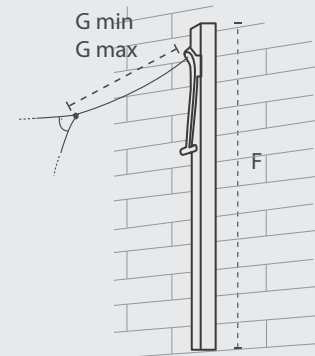
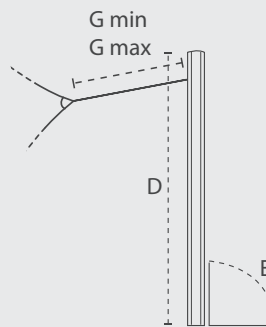

	A cm/ft	B cm/ft	C	D cm/ft	E	F cm/ft	G min cm/ft	G max cm/ft	H cm/inch	H+I cm/ft
INGENUA   +/- 2% +-----+  -----	260/8' 7" 300/9' 10"	65/2' 1.6" 75/2' 5.5"	80°	260/8' 7"	90°	165/5' 5"	50/1' 8"	150/4' 11"	20/8"	<500/<16' 5"

MATERIALS

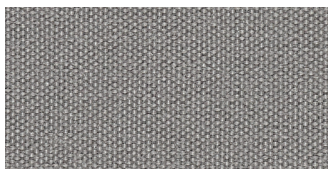

**FABRIC**  
 Solidum – 100% Acryl 255 gr/m<sup>2</sup>  
 Sunbrella – 100% Acryl 260 gr/m<sup>2</sup>  
 More details – see spec sheet Fabrics



**POLE**  
 Naturally anodized aluminum  
 White – RAL 9016 TEC  
 Dusk – RAL 8022 TEC



**OTHER MATERIALS**  
 Carabiner: stainless steel 316 (marine grade)  
 Handle: stainless steel 316 (casted & polished)  
 Rope: Ø 6mm/0,24"

For projects – consult Umbrosa for powder coating finish options (RAL).

## PACKAGING &amp; TRANSPORT

Ingenua	L (cm)	W (cm)	H (cm)	Weight (kg)	L (")	W (")	H (")	Weight (lbs)
Box pole	270	10	8,5	7,3	8'10"	4"	3"	16
Bag Sail	45	55	16	2,23 - 5,26	1'5"	1'10"	6"	5-11

## NICE TO KNOW

- Spare parts available
- Designed and manufactured in Belgium
- Warranty between 15 and 2 years, see Warranty Sheet
- Manual included
- Storage bag included (PU coated fabric)
- Wind speeds up to 6 beaufort, 50 km/h, 31 mph when base is permanently fixed
- Tested at TU Delft